



Advanced Instruments Inc.

Technical Specifications *

Accuracy:	2% of FS range under constant conditions
Analysis:	0-20, 0-50, 0-100 PPM FS ranges; Auto-ranging or manually lock on single range
Application:	Trace H ₂ S in flowing gas streams
Approvals:	Certified for use in hazardous areas - see lower right UL: United States: UL 1203, UL 913, UL 508 Canada: CAN/CSA C22.2 No. 30-M1986, CAN/CSA C22.2 No. 157-92, CAN/CSA C22.2 No. 14-10 ATEX: Directive 94/9/EC
Area Classification:	Certified for use in hazardous areas - see lower right
Alarms:	Two user configurable alarms: magnetic coil relays rated 3A at 100 VAC, programmable alarm delays, alarm bypass for calibration and system fail alarm
Calibration:	Recommended Span gas 20-50 PPM H ₂ S balance air/nitrogen
Compensation:	Barometric pressure (ATEX only)
Connections:	1/4" Sample/Span; 3/8" Vent line.
Controls:	Water resistant keypad; menu driven range selection, calibration and system functions
Display:	Graphical LCD 2.75" x 1.375"; resolution 0.1 PPM; displays real time ambient temperature and pressure
Enclosure:	NEMA Type 3R for rain in outdoor applications (UL) NEMA 4X (ATEX)
Flow:	Maintain constant flow at 1 SCFH, maintain Sample to Air ratio of 1:1
Linearity:	±2% of full scale
Pressure:	Inlet - regulate to 5-30 psig to deliver constant 1 SCFH flow; vent - atmospheric
Power:	12-28 VDC (UL or ATEX Certified) 110-220 VAC (ATEX Certified) Transmitter, 12-24 VDC PUMP
Response Time:	90% of final reading in 60 seconds
Sample System:	Flow through SS sensor housing, flow control valve, sample flow meter, 3-way sample/span valve, air pump, air flow meter
Sensitivity:	< 0.5% of FS range
Sensor Model:	OSV-72-7HH-LD (standard ranges)
Sensor Life:	24 months at 25°C and 1 atm
Signal Output:	4-20mA or 1-5 VDC
Operating Range:	-10 °C to 45°C
Warranty:	12 months analyzer; 12 months sensor
Wetted Parts:	Stainless steel

UL or ATEX Certified for Hazardous Areas



GPR-7500 AIS-LD PPM H₂S Analyzer

Full Featured H₂S Analyzer

Exia
UL Certified
File E343386
Class I, Division 1, Groups C and D
T4 T_{amb} -20°C to +50°C

ATEX Certified - Directive 94/9/EC
Examination Cert: INERIS 08ATEX0036
II 2 G
Ex d [ib] ib IIB T4 Gb
T_{amb} -20°C to +50°C
 0080

ISO 9001:2008 Certified
INTERTEK Certificate No. 485

Optional Equipment

- Additional sample conditioning systems - Contact factory
- OSV-72-7H-LD sensor for 0-500 PPM, 0-1000, 0-2000 PPM FS ranges

* Specifications subject to change without notice

GPR-7500-AIS-LD

PPM H₂S Transmitter

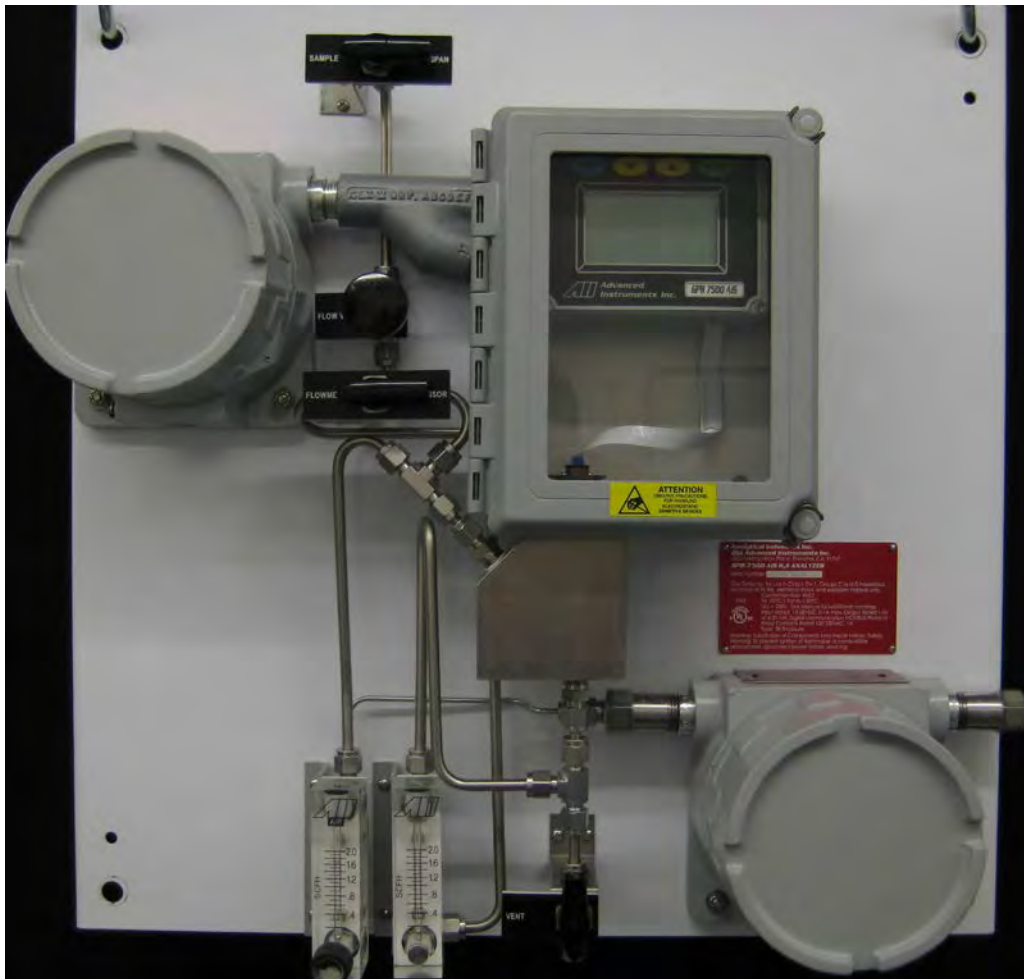

Owner's Manual

Revised June 2014

Table of Contents

Introduction		1
Quality Control Certification		2
Safety		3
Features & Specifications		4
Operation		5
Maintenance		6
Spare Parts		7
Troubleshooting		8
Warranty		9
Material Safety Data Sheets		10
Drawings		A/R
Explosion Proofing Electrical Connections	Appendix	A
Correlating readings – LCD display to 4-20mA signal output	Appendix	B
H2S Scrubber, Sample System, Media MSDS	Appendix	F
Maintenance H2S Scrubber & Coalescing Filter	Appendix	G

The appendices referenced above are an integral part of the documentation, installation and maintenance of this analyzer to comply with all applicable directives. It is important that users review these documents before proceeding.

1. Introduction

Your new Hydrogen Sulfide Analyzer incorporates an advanced electrochemical sensor specific to hydrogen sulfide along with state-of-the-art digital electronics designed to give you years of reliable precise measurements of hydrogen sulfide in a variety of industrial applications. More importantly, it has been constructed as explosion proof/intrinsically safe in accordance with Safety Standard EN 60079-0:2009, EN 60079-1:2007 and EN 60079-11:2012, UL 913 Seventh Edition and CSA C22.2 No. 157-92 Third Edition, for use in Class I, Div 1, Groups C and D hazardous locations. It also conforms to ATEX Directives 94/9/EC for use in hazardous areas in zone 1 Group C and D

Please refer to Appendix A for information on making electrical connections that maintain the desired level of protection.

To obtain maximum performance from your new hydrogen sulfide transmitter, please read and follow the guidelines provided in this Owner's Manual.

Every effort has been made to select the most reliable state of the art materials and components, to design the transmitter for superior performance and minimal cost of ownership. This transmitter was tested thoroughly by the manufacturer prior to shipment for best performance.

However, modern electronic devices do require service from time to time. The warranty included herein plus a staff of trained professional technicians to quickly service your transmitter is your assurance that we stand behind every transmitter sold.

The serial number of this transmitter may be found on the inside the transmitter enclosure. You should note the serial number in the space provided and retains this Owner's Manual as a permanent record of your purchase, for future reference and for warranty considerations.

Serial Number: _____

Advanced Instruments Inc. appreciates your business and pledges to make every effort to maintain the highest possible quality standards with respect to product design, manufacturing and service.

2. General Safety & Installation

This section summarizes the essential precautions applicable to the GPR-7500 AIS Hydrogen Sulfide Analyzer. Additional precautions specific to individual transmitter are contained in the following sections of this manual. To operate the transmitter safely and obtain maximum performance follow the basic guidelines outlined in this Owner's Manual.



Caution: This symbol is used throughout the Owner's Manual to Caution and alert the user to recommended safety and/or operating guidelines.



Warning: This symbol is used throughout the Owner's Manual to Warn and alert the user of the presence of electrostatic discharge.



Danger: This symbol is used throughout the Owner's Manual to identify sources of immediate Danger such as the presence of hazardous voltages.

Read Instructions: Before operating the transmitter read the instructions.

Retain Instructions: The safety precautions and operating instructions found in the Owner's Manual should be retained for future reference.

Heed Warnings: Follow all warnings on the transmitter, accessories (if any) and in this Owner's Manual.

Follow Instructions: Observe all precautions and operating instructions. Failure to do so may result in personal injury or damage to the transmitter.

Analyzer Label ULc, (ATEX label not shown for clarity)

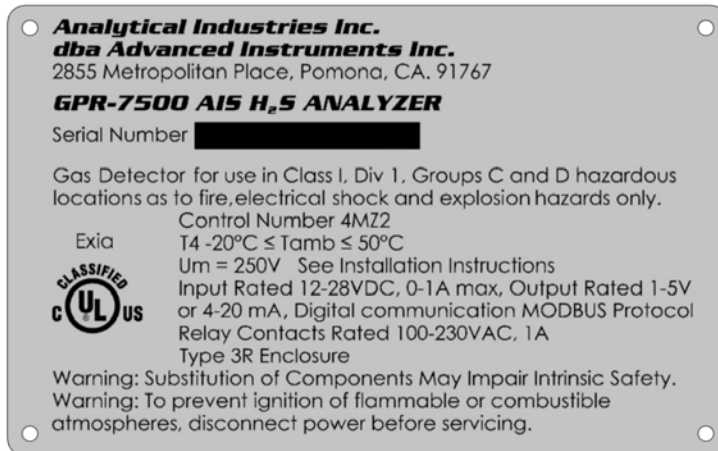

WARNING – Potential Explosion Hazard: The devices are not intended for use in atmospheres or with sample gas streams containing oxygen concentration greater than 21 percent by volume (ambient air) and are only intended for use in gases or gas mixtures classified as Class I, Div 1, Groups C and D hazardous locations, when used in the United States or Canada.

2. Quality Control Certification

See Packing slip.

3. Maintenance

Serviceability: Except for replacing the hydrogen sulfide sensor, there are no parts inside the transmitter for the operator to service.

WARNING- Substitution of Components May Impair Intrinsic Safety

Only trained personnel with the authorization of their supervisor should conduct maintenance.

H₂S Sensor: DO NOT open the sensor. The sensor contains a corrosive liquid electrolyte that could be harmful if touched or ingested, refer to the Material Safety Data Sheet contained in the Owner's Manual appendix. Avoid contact with any liquid or crystal type powder in or around the sensor or sensor housing, as either could be a form of electrolyte. Leaking sensors should be disposed of in accordance with local regulations.

Troubleshooting: Consult the guidelines in Section 8 for advice on the common operating errors before concluding that your transmitter is faulty. Do not attempt to service the transmitter beyond those means described in this Owner's Manual.

Do not attempt to make repairs by yourself as this will void the warranty as per Section 10 and may result in electrical shock, injury or damage. All other servicing should be referred to qualified service personnel.

Cleaning: The analyzer should be cleaned only as recommended by the manufacturer. Wipe off dust and dirt from the outside of the unit with a soft damp cloth then dry immediately. Do not use solvents or chemicals.

Non-use Period: If the analyzer is equipped with a range switch advance the switch to the OFF position and disconnect the power when the transmitter is left unused for a long period of time.

Installation

This analyzer has been constructed in compliance with

EN 60079-0 : 2009

EN 60079-1 : 2007

EN 60079-11 : 2012

ATEX Directive 94/9/EC

For USA and Canada

UL 913, 7th Edition

CSA C22.2 No. 157-92

It must be installed in accordance with

EN 60079-14

For USA - NEC and Canada – CEC Standards

WARNING - Potential Explosion Hazard – See Warning in Section 4 – Features and Specifications

Sampling Stream: Ensure the gas stream composition of the application is consistent with the specifications and if in doubt, review the application and consult the factory before initiating the installation. **Note:** In natural gas applications such as extraction and transmission, a low voltage current is applied to the pipeline itself to inhibit corrosion of the pipeline. As a result, electronic devices connected to the pipeline can be affected unless they are adequately grounded.

Contaminant Gases/Liquids in Sample Stream: A sample flow indicator with integral metering valve is required upstream of the analyzer to remove any interfering gases such as oxides of sulfur and nitrogen that can interfere with measurement. Sample must be free from any condensable liquid. With gas streams containing condensable liquids, a coalescing filter must be installed upstream of the sensor. Consult the factory for recommendations concerning the proper selection and installation of sample conditioning requirements.

Expected Sensor Life: With reference to the publish specification located in Section 4 of this manual, the expected life of all H₂S sensors is predicated on the rate of loss of electrolyte from the sensor at temperature of

77°F/25°C and pressure of 1 atmosphere in “normal” applications. Deviations from standard conditions will affect the life of the sensor (temperature higher than 77°C and pressure less than atmospheric would cause a reduction in the sensor life).

Accuracy and Calibration: Refer to section 5 Operation.

Material and Gases: Assemble the necessary zero, sample and span gases and optional components such as valves, coalescing or particulate filters, and pumps as dictated by the application. Stainless steel tubing is essential for maintaining the integrity of the gas stream for low PPM H₂S level analysis.



Operating Temperature: The sample must be sufficiently cooled before it enters the analyzer and any optional components. A coiled 10 foot length of ¼” stainless steel tubing is sufficient for cooling sample gases as high as 1,800 °F to ambient. The recommended operating temperature is below 35 °C. However, the analyzer may be operated at temperature up to 45 °C on an intermittent basis but the user is expected to accept a reduction in expected sensor life –as a rule of thumb, for every degree °C increase in temperature (above 25 °C), the sensor life is reduced by approximately 2.5%.

Warning – Sample Stream entering unit must never exceed 50 °C

Heat: Install the analyzer away from direct sun and from any source of heat. Situate and store the analyzer away from direct sources of heat.

Liquid and Solid Object Entry: The analyzer should not be immersed in any liquid. Care should be taken so that liquids are not spilled into and objects do not fall on or inside of the analyzer.

Handling: Do not use force when using the switches, knobs or other mechanical components. Before moving your analyzer be sure to disconnect the wiring/power cord and any cables connected to the output terminals of the analyzer.

Sample Pressure and Flow

All electrochemical sensors respond to partial pressure changes in the gas of interest. The sensors are equally capable of analyzing the H₂S content of a flowing sample gas stream or monitoring the H₂S concentration in ambient air (such as a confined space in a control room or an open area around a landfill or bio-pond). The following is applicable to analyzers equipped with electrochemical sensors.

Analyzers designed for in-situ ambient or area monitoring has no real sample inlet and vent. The sensor is exposed directly to the sample gas and it is intended to operate at atmospheric pressure. The analyzer has a built-in pressure sensor and the sensor output is automatically compensated for any atmospheric pressure changes. The analyzers function equally well with sample gas flowing across the sensor provided the sample does not produce any positive pressure or create a partial vacuum on the sensor. For positive sample pressure applications, suitable means must be employed to control the sample flow without subjecting the sensor to high sample pressure. For applications where the sample is less than atmospheric pressure, consult factory before initiating installation.

Inlet Pressure: For the analyzers designed to measure H₂S in a flowing gas stream, the inlet sample pressure must be regulated between 5-30 psig. Although the rating of the SS tubing and tube fittings/valves itself is considerably higher (more than 100 psig), a sample pressure of 5-30 psig is recommended for ease of control of sample flow.

The analyzer equipped with a sample system has designated SAMPLE and VENT ports. Connect SAMPLE gas to SAMPLE and the vent to the VENT ports only.

Outlet Pressure: In applications where sample pressure is positive, the sample must be vented to an exhaust pipe at a pressure less than the inlet pressure so that the sample gas can flow through the sensor housing. Ideally, the sample must be vented to atmospheric pressure.

Note: The sensor may be used at a slight positive pressure (e.g., when sample is vented to a common exhaust where the pressure might be higher than 1 atmosphere). However, the pressure at the sensor must be maintained at all times including during the span calibration. This may be accomplished by using a back-pressure regulator, (set at no greater than 0.2 PSIG) at vent line of the analyzer. **Caution:** A sudden change in pressure at the sensor may result in the sensor electrolyte leakage and permanent damage to the sensor.

Application, Positive-Pressure Analyzer is equipped with integral flow control valve upstream of the sensor. If necessary, a pressure regulator upstream of the flow control valve should be used to regulate the inlet pressure between 5-30 psig.

Flow rates of 1 SCFH is recommended and must be maintained close to this value as the sample is blended with air (see below) continuously. A significant variation of the flow rate may affect the sensor signal output to a level that it wouldn't calibrate.

Air Flow: The air flow (from the integral pump mounted in a separate Ex enclosure, see page 17) is set at 1 SCFH and is constantly blended with the sample gas. Sample flow rate of 1 SCFH is recommended and must be maintained during analysis. The air to sample flow ratio of 1:1 must be maintained at all times (during calibration as well as during analysis).



Caution: Failure in maintaining the sample to air flow ratio will cause an error in the H₂S reading (as a percent of the reading) equivalent to the new sample to air flow ratio (see Section 5 page 25-26 for details).

Moisture & Particulates: The analyzer is equipped with a special flow through housing that allows the moisture/free liquids mixed with particulates to flow across the sensor where the gravity pulls the liquids/particulates through and allowing the gas to diffuse upward towards the sensor's sensing surface thus eliminating the need to separate liquids from the sample before analysis.

Mounting of the Transmitter: The transmitter is approved for indoor as well as outdoor use. However, avoid mounting in an area where direct sun might heat up the analyzer beyond the recommended operating temperature range. If possible, install a small hood over the analyzer for rain water drain and to prevent over-heating of analyzer. **If the ambient temperature is expected to fall below -18 degree C (0 degree F), install the analyzer within an heated enclosure**

Gas Connections: The Inlet and outlet vent gas lines require ¼" and 3/8" stainless steel compression type tube fittings. The sample inlet tubing must be metallic, preferably SS. The sample vent line may be of SS or hard plastic tubing with low gas permeability.

Power Requirement: Supply power to the analyzer only as rated by the specification or markings on the analyzer enclosure. The GPR-7500AIS-LD is powered by 12-28 VDC. A separate 12 or 24 VDC power is required for air pump housed in a separate enclosure. The wiring that connects the analyzer and pump to the power source should be installed in accordance with recognized electrical standards. Ensure that the analyzer case is properly grounded and meets the requirements for area classification where the analyzer is installed. Never yank wiring to remove it from a terminal connection.

Power Consumption: The maximum power the analyzer consumes is no more than 7 Watts (without the heater option).

4. Features & Specifications



Technical Specifications *

Accuracy:	2% of FS range under constant conditions
Analysis:	0-20, 0-50, 0-100 PPM FS ranges; Auto-ranging or manually lock on single range
Application:	Trace H2S in flowing gas streams
Approvals:	Certified for use in hazardous areas - see lower right UL: United States: UL 1203, UL 913, UL 508 Canada: CAN/CSA C22.2 No. 30-M1986, CAN/CSA C22.2 No. 157-92, CAN/CSA C22.2 No. 14-10 ATEX: Directive 94/9/EC
Area Classification:	Certified for use in hazardous areas - see lower right
Alarms:	Two user configurable alarms: magnetic coil relays rated 3A at 100 VAC, programmable alarm delays, alarm bypass for calibration and system fail alarm
Calibration:	Recommended Span gas 20-50 PPM H2S balance air/nitrogen
Compensation:	Barometric pressure, temperature not required
Connections:	1/4" Sample/Span; 3/8" Vent line.
Controls:	Water resistant keypad; menu driven range selection, calibration and system functions
Display:	Graphical LCD 2.75" x 1.375"; resolution 0.1 PPM; displays real time ambient temperature and pressure
Enclosure:	NEMA Type 3R for rain in outdoor applications
Flow:	Maintain constant flow at 1 SCFH, maintain Sample to Air ratio of 1:1
Linearity:	±2% of full scale
Pressure:	Inlet - regulate to 5-30 psig to deliver constant 1 SCFH flow; vent - atmospheric
Power:	12-28 VDC (UL or ATEX Certified) 110-220 VAC (ATEX Certified) Transmitter, 12 or 24 VDC PUMP
Response Time:	90% of final reading in 90 seconds
Sample System:	Flow through SS sensor housing, flow control valve, sample flow meter, 3-way sample/span valve, air pump, air flow meter
Sensitivity:	< 0.5% of FS range
Sensor Model:	OSV-72-7H-HLM (standard ranges)
Sensor Life:	24 months at 25°C and 1 atm
Signal Output:	4-20mA or 1-5 VDC
Operating Range:	-10 °C to 45°C
Warranty:	12 months analyzer; 12 months sensor
Wetted Parts:	Stainless steel

UL or ATEX Certified for Hazardous Areas



GPR-7500 AIS-LD

Exia

CLASSIFIED
c **UL** **US**

UL Certified
File E343386

Class I, Division 1, Groups C and D
T4 T_{amb} -20°C to +50°C

ATEX Certified - Directive 94/9/EC
Examination Cert: INERIS 08ATEX0036

II 2 G
Ex d [ib] ib IIB T4 Gb
T_{amb} -20°C to +50°C

0080

ISO 9001:2008 Certified
INTERTEK Certificate No. 485

Optional Equipment

- Additional sample conditioning systems - Contact factory
- OSV-72-7H-HLM sensor for 0-500 PPM, 0-1000, 0-2000 PPM FS ranges

* Specifications subject to change without notice

***WARNING** - Potential Explosion Hazard : The devices are not intended for use in atmospheres containing more than 21% oxygen (ambient air) and are only intended for use with or in gases or gas mixtures classified as Class I, Div 1 Groups C and D hazardous location gases when used in the United States or Canada.

****NOTE 1:** Optional Sampling system shown is not part of UL/cUL Classification.

5. Operation

Principle of Operation

The GPR-7500AIS-LD H₂S Transmitter incorporates a variety of advanced electrochemical sensors. These sensors are very specific to H₂S and generate an electrical signal proportional to the amount of H₂S present in a gas stream. The selection of a particular type of sensor depends on the maximum concentration of H₂S contents in the sample stream. Consult the factory for recommendation.

The transmitter is configured in two sections. The signal processing electronics and sensor are housed in a general purpose NEMA 4X rated enclosure. The terminals of power input, signal output and the intrinsic safety barriers are mounted on a PCB housed in an explosion proof enclosure.

The two sets of electronics are interconnected using an explosion proof Y-fitting, explosion proof packing fiber and sealing cement. Once connected, the intrinsic safety barriers limit the amount of power that flows to and from the signal processing electronics effectively preventing an explosive condition.

Air pump is housed in a separate explosion proof enclosure and requires 12 or 24 VDC power through a separate conduit. The pump supplies air at a constant flow that is blended with sample stream continuously.

The GPR-7500AIS-LD meets the ULc and ATEX intrinsic safety standards required for use in Class I, Division 1, Group C, D hazardous areas.



Advanced Electrochemical Sensor Technology

All electrochemical sensors driven by a bias potential (three electrode configuration) function on the same principle and are specific to a certain gas. They measure the partial pressure of the target gas from low PPM to up to 1% levels in air, inert gases and gaseous hydrocarbons.

The target gas, in this case, Hydrogen Sulfide, diffuses into the sensor through a diffusion limiting membrane, reacts electrochemically at the sensing electrode and produces an electrical current output proportional to the H₂S concentration in the gas phase. The sensor's signal output is linear over all measuring ranges and remains virtually constant over its useful life. The sensor requires no maintenance and is easily and safely replaced at the end of its useful life.

Proprietary advancements in the design and chemistry of the sensor's components add significant advantages to this extremely versatile H₂S sensing technology. The sensor maintains its accuracy to within +/-5% of its span (it does not sleep during continuous use; a typical symptom seen with conventional electrochemical H₂S sensors) over a 1-3 months period. To maintain accuracy over the useful life of the sensor, calibration of the sensor every 30 days is recommended. Under normal use, the sensor is expected to last from 18-24 months.

The H₂S sensor recovers from an upset condition (exposure to very high H₂S) to low PPM level in a matter of few minutes.

NOTE- Check the product label for safe operating conditions

Electronic

The signal generated by the sensor is processed by state of the art low power micro-processor based digital circuitry. The first stage amplifies the signal. The second stage eliminates the low frequency noise. The third stage employs a high frequency filter. The result is a very stable signal that reflects H₂S concentration in the sample very accurately. Response time of 90% of full scale is less than 60 seconds on all ranges (actual experience may vary due to the

integrity of sample line connections, dead volume and flow rate selected) under ambient analysis conditions. Sensitivity is typically 0.5% of full scale of the low range. The display has the resolution of 0.1 PPM H₂S (on 0-20 PPM Full scale range). The analog output signal may be recorded by on external device via the 4-20 mA or optional 1-5V signal.

Sample System

See Section 4, Features and Specification, Note 1 for exclusions.

The standard GPR-7500AIS-LD is supplied with a sample conditioning system consisting of Sample/Span valve, sample flow control valve and meter, air pump (housed in a separate Ex enclosure), sample/span needle flow control valve and air flow meter. The sample and air are blended continuously with 1:1 SCFH ratio and must be maintained at all time.

The sample is assumed to be saturated with free liquid, however, a Sample/Sensor 3-way valve is included to set the sample flow (with no condensate) or the Span gas flow rate. This is achieved by a needle valve situated upstream of the 3-way valves; set the 3-way valve to "sampler" position to set the flow rate. During normal sampling, turn the 3-way valve to "sensor" position.



3-way Sample/Sensor valve and sample flow control needle valve

Note: It is highly recommended to set the sample and span gas pressure within 5 PSIG to prevent a sudden increase/decrease in sample/span gas flow rate when switching between sample and span gas.

Advanced Instruments Inc. offers a full range of sample handling, conditioning and expertise to meet your application requirements. Contact us at 909-392-6900 or e-mail us at info@aii1.com for recommendation.

Calibration and Accuracy Overview

Single Point Calibration: As previously described, the electrochemical H₂S sensor generates an electrical current proportional to the H₂S concentration in the sample gas. In the absence of H₂S the sensor exhibits an absolute zero, e.g. the sensor does not generate a current output in the absence of H₂S. Given these linearity and absolute zero properties, single point calibration is possible.

Sample Pressure: Since the sensor is sensitive to the partial pressure of H₂S in the sample gas, the output is a function of the number of molecules of H₂S per unit volume. When sample is vented to the atmosphere the sensor essentially remains at atmospheric pressure. However, a positive or negative pressure on the sensor will alter the output of the sensor and unless the sensor is calibrated under the same analysis conditions, a significant error in measurements will occur.

Note: To maintain a constant Sample flow and prevent any back pressure on the sensor, regulate the pressure between 5-30 PSIG, keep the sample flow at 1 SCFH and vent the sample to atmosphere

CAUTION: Any blockage of the sample vent line will cause an increase in pressure at the sensor. If sample is to be vented into a pipe above atmospheric pressure, a pressure regulator set at 0.2 PSIG must be installed to maintain constant pressure on the sensor. For vent pressure above 0.2 PSIG, consult factory for proper selection of electronics.

Ambient Temperature: The rate at which H₂S molecules diffuse into the sensor is controlled by a Teflon membrane otherwise known as an 'H₂S diffusion limiting barrier'. All diffusion processes are temperature sensitive, therefore, the fact that the sensor's electrical output will vary with temperature is normal. Under typical applications, this variation is relatively small and the measurement accuracy remains within the published specifications over the recommended operating range of temperature. The accuracy of ±5% or better over an operating temperature range e.g.,

5-45°C can be obtained. The measurement accuracy will be the highest if the calibration and sampling are performed at similar temperatures (a temperature variation of 10 °F may produce an error of >+/-2% of full scale).

Accuracy: In light of the above parameters, the overall accuracy of an analyzer is affected by two types of errors, 'percent of reading errors', illustrated by Graph A below and the 'percent of full scale errors', illustrated by Graph B. The percent of reading error is contributed by incorrect calibration procedure whereas the percent of full scale error is contributed by tolerance in components and the measurement device. These errors are 'spanned out' during calibration, especially when span calibration is done close to the top end of the measuring range followed by a zero calibration.

Graph C illustrates these 'worse case' specifications that are typically used to develop an overall accuracy statement of < 2% of full scale at constant temperature or < 5% over the operating temperature range. The QC testing error at the factory is typically < 1% of full scale.

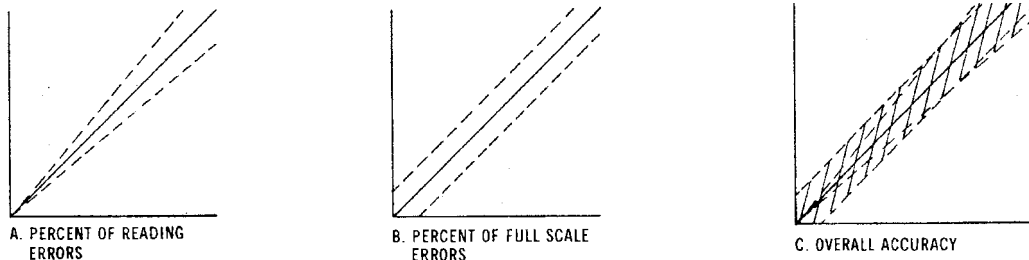

Example 1: Graph A, percent of reading error, this error is more pronounced when a span adjustment is carried out at the lower end of the scale, e.g., when span calibration is done by 20 PPM span gas on a 100 PPM full scale range, any error at 20 PPM span gas would be multiplied by a factor of 5 (100/20) when making measurements close to 100 PPM. Conversely, an error during a span adjustment close to the top end of the range, e.g., at 100 PPM would reduce the error proportionately for measurements near the bottom end of the range.

Graph B represents a constant error over the entire measuring range. This error is generally associated with the measuring e.g., LCD and or calibrating devices, e.g., current simulator or current/voltage measuring devices.

Graph C shows the overall accuracy of the measurement.

Potential Explosion Hazard – See warning in Section 4 – Features and Specifications

Mounting of the Transmitter

The GPR-7500AIS-LD transmitter consists of two interconnected enclosures. This configuration is designed to be mounted directly to any flat vertical surface, wall or bulkhead plate by using eight (4) of the appropriate screws.

To facilitate servicing the interior of the transmitters, secure the back plate to a vertical surface approximately 5 feet from the floor or a level accessible to service personnel. This requires the user to supply four (4) additional proper size screws and anchors.



Caution: Do not remove or discard the gaskets from either the Ex enclosure or the fiberglass enclosure. Failure to reinstall either of the gaskets will void the NEMA 4, UL Type 3R rating and the immunity to RFI/EMI.

The transmitters design provides immunity from RFI/EMI by maintaining a good conductive contact between the two halves of the enclosures via a conductive gasket (the smaller enclosure containing signal processing electronics). The surfaces contacting the conductive gasket are unpainted. Do not paint these areas. Painting will negate the RFI/EMI protection.



As a safety, connect the vent line of analyzer to a vent pipe for safe venting of sample gas.



Sample system shown with Sample flow indicator, Air flow meter and sample flow through housing

Shut off valve

Enclosure containing air pump

See Section 4 – Features and Specifications, for exclusions

Gas Connections

The GPR-7500AIS-LD with its standard flow through configuration is designed for positive pressure samples and requires connections for an incoming sample and an outgoing vent line. A span inlet ports is offered as part of the sample systems. The user is responsible for calibration gases and other required components, see below.

CAUTION: Before allowing the Sample gas to flow through the analyzer, make sure the Air Pump (housed in a separate Ex enclosure) is powered up and the air flow is set at 1 SCFH. Under rare conditions, you may need to adjust potentiometer (adjacent to the pump ON/OFF switch) to adjust the pump speed to ensure a constant 1 SCFH air flow.

Procedure

1. Connect the sample to SAMPLE and vent to the VENT port as marked on the panel.
2. Regulate the sample pressure as described in "Pressure and Flow" section above.
3. Connect a 3/8" vent line to the compression fitting to be used for venting the SAMPLE.
4. Connect a 1/4" sample line to the compression fitting to be used to bring SAMPLE gas to the analyzer.
5. Connect span gas to SPAN port of the analyzer
6. Turn the air pump ON and set the air flow to 1 SCFH
7. Set the SAMPLE and SPAN gas pressure between 5-30 psig, keep the sample and span gas pressure within 5 PSIG of each other for a better gas flow control.
8. Turn the 3-way Sample/Sensor valve to "sample"
9. Set 3-way sample/span valve to "sample" Use the needle valve upstream of 3-way sample/sensor valve and set the sample flow rate at 1 SCFH.
10. Set air flow at 1 SCFH
11. Turn the 3-way sample/sensor valve to "sensor"
12. Analyzer will immediately respond to H₂S in the sample gas

Maintain the SAMPLE and AIR flow rates at 1 SCFH to keep sample to air ratio of 1:1 at all times (during sampling as well as during span calibration)



As a safety, connect the vent line of analyzer to a vent pipe for safe venting of sample gas

Electrical Connections

The Incoming power, alarm relays, and signal output connections are made to terminal blocks mounted on a PCB located in the explosion proof enclosure.



Do not supply voltage above the noted value in this manual and noted near the power input terminal of the analyzer.

The PCB in the explosion proof enclosure contains a power limiting intrinsic safety barrier that limit the total power available at the PCB electronics mounted in the general purpose enclosure.

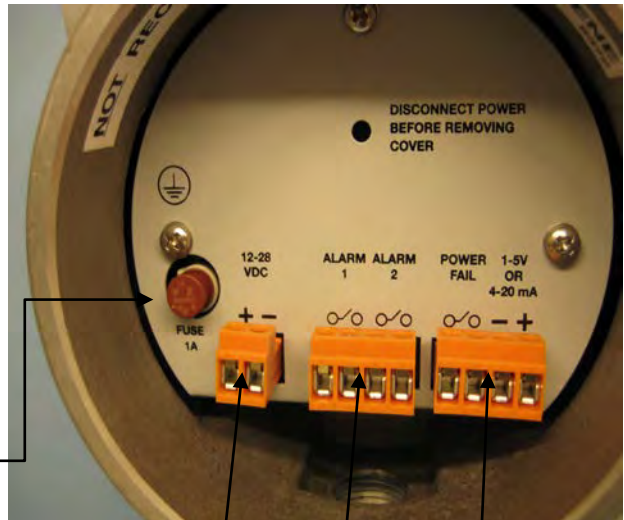

200 mA Fuse

Power In 12-28 VDC 2 Alarm Relays Power Fail & Signal Out

The GPR-7500-AIS-LD meets the intrinsic safety standards required for use in Class I, Division 1, Group C, D hazardous areas.

ATEX Directive 94/9/EC



II 2 G

Ex d ib IIB T4 Gb

T_{amb} -20°C to +50°C

For USA and Canada, it conforms to

UL 913, 7th Edition

CSA C22.2 No. 157-92

The A-1166 AIS PCB in the Ex enclosure contains five fuses, one plug-in (brown color) rated at 200 mA and the rest are mounted on the PCB (after the DC voltage is regulated to lower safe value, these fuse meet barrier network standard EN 50020).



Analyzer ground terminal must be connected to ground



Avoid electrostatic discharge – Clean all surfaces with a damp cloth only.

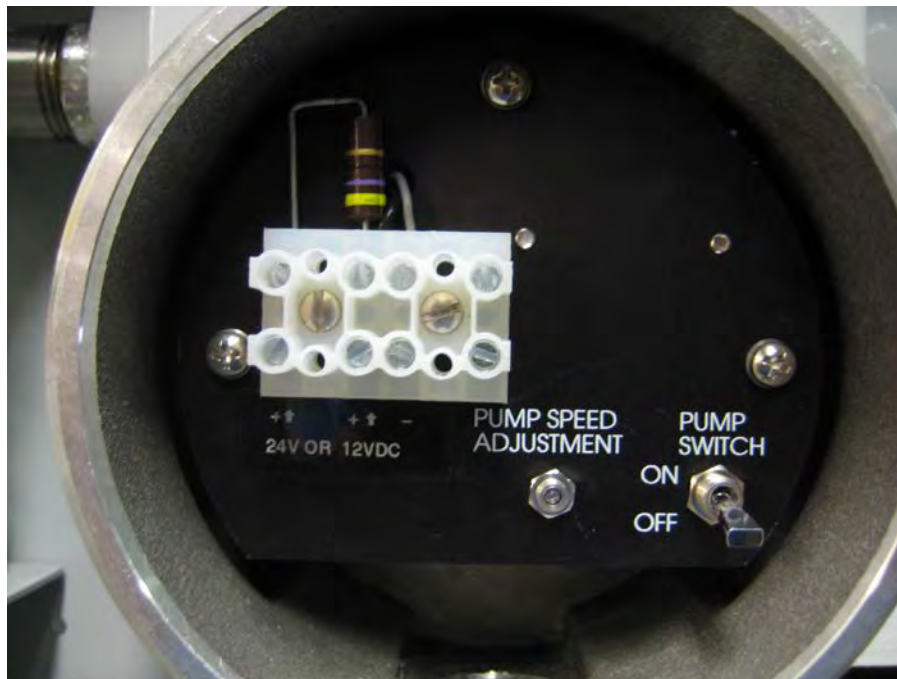

Air pump power connection, pump speed adjustment and power ON/OFF

The power to the Air Pump is to be provided separately and must run through an approved conduit. Pump is set to accept 12 or 24 VDC, ensure that 12 VDC power is connected to 12 VDC terminal or if 24 VDC is used, it is connected to 24 VDC terminal.

After establishing power, turn the pump switch to ON position.

In rare cases, the user may need to adjust the pump speed to get proper air flow. If an adjustment is needed, open the air flow meter completely and turn the potentiometer clockwise or anti-clockwise until the air flow is 2 SCFH. Leave the potentiometer at the set position and adjust the air flow to 1 SCFH.

Secure the lid of the Ex enclosure after establishing power.

Hazardous Area Installation

The GPR-7500AIS-LD may be installed in a hazardous area when adhered to the recommended installation procedure delineated above mentioned directives; see page 6.

Power Input

A 12-28 VDC power supply with a shielded power cable is recommended. The power cable to the Ex enclosure must be supplied through a conduit approved for use in hazardous area. Secure the wires to the power input terminal block by using the integral screws of the terminal block. Do not substitute terminal screws.

Power to air pump requires 12 or 24 VDC and must run through a separate conduit approved for hazardous area.



CAUTION: Check the QC for the proper power requirement. Incorrect power will severely damage the analyzer

Output Connections

The transmitter has two adjustable alarms, one power fail alarm and 4-20 mA or 1-5 VDC signal output connections.

CAUTION: The 4-20mA circuit does not require external power. Supplying external power to the PCB will permanently damage the PCB.

The HI and LOW alarms are user configurable. The relays are rated at 1A @ 230 VAC.

CUTION: Do not exceed the recommended rating of the relays. Excessive power through the relays can severely damage the relays and the PCB.

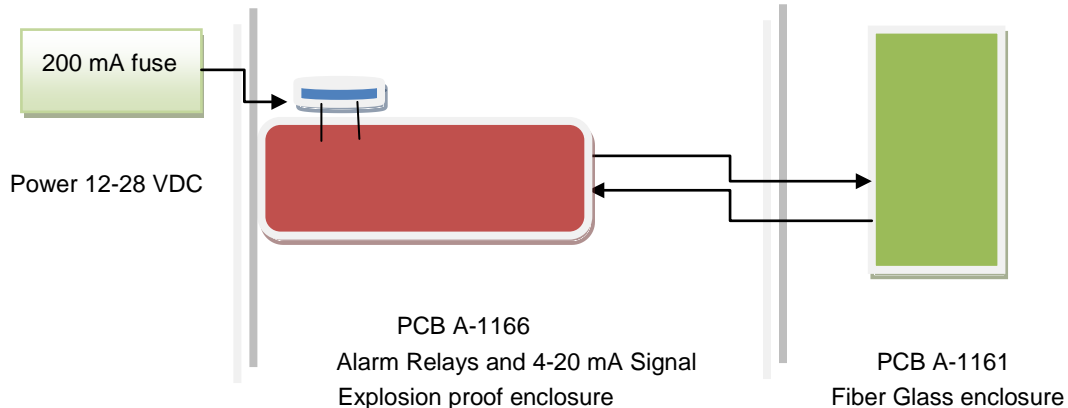

There are total five wire connections between the Ex enclosure and the fiber glass enclosure but for simplicity, only two connections are shown.

Procedure

1. Unscrew the cone shaped cover from the EX enclosure.
2. Separate the shielding from the wires of the cables.
3. Strip the end of wires no greater than 1/4"
4. Insert the stripped end of wires into the appropriate slots of the terminal block
5. Ensure the positive and negative terminals of the power supply are connected to the appropriate terminals of the terminal block as marked.
6. Tighten the screws and ensure the wires are properly secured.

7. Connect the shielding of the cable to the ground screw inside of the enclosure.
8. Follow the same procedure and establish alarm relays and 4-20 mA signal connections with appropriate terminals
9. Replace the cover.

Note: The male and female power terminals snap together, making it difficult to detach them when connecting the shield to the ground. However, after connecting the shield, ensure that the male terminal is fully inserted and secured into the female terminal block.

Installation of H2S Sensor

The GPR-7500 AIS-LD Analyzer is equipped with SS sensor housing. The sensor is housed in the fiber glass enclosure. The sensor housing offers ease of replacement of sensor and at the same time prevents any leakage into the system. The sensor is screwed in and makes the seal against the flat surface of the sensor housing with the integral O-ring on the sensor's threaded front end.



Caution: DO NOT dissect the sensor. The sensor contains a corrosive liquid electrolyte that could be harmful if touched or ingested, refer to the Material Safety Data Sheet contained in the Owner's Manual appendix. Avoid contact with any liquid or crystal type powder in or around the sensor or sensor housing, as either could be a form of electrolyte. Leaking sensors should be disposed off in a manner similar to that of a common battery in accordance with local regulations.

Should the transmitter come without sensor installed or need to install a new sensor, follow the guidelines give below.

Procedure

1. Turn the power to analyzer OFF.
2. Remove the two (2) clamps securing the right side corners and open the door of the fiber glass enclosure.
3. Remove the PCB along with the ribbon cable from the top of the sensor by gently pulling the connector on the sensor PCB.



Avoid electrostatic discharge – touch a metal surface with your bare hand before contacting the PCB.
Clean all surfaces with a damp cloth only

4. Unscrew the sensor by turn the sensor anti clockwise.
5. Remove the new sensor from the bag.
6. Screw the new sensor in to the sensor housing until finger tight.
7. Align 4 pins of the sensor PCB with 4 pins of the sensor and gently push the PCB on to the sensor until it is firmly seated. Ensure that the ribbon cable is firmly attached to the PCB
8. If ribbon cable is detached, insert the ribbon cable as shown and then push down the two levers of the connector.



Sensor shown with ribbon cable half inserted showing the conducting bars facing COND on PCB

Levers on side of ribbon cable connector

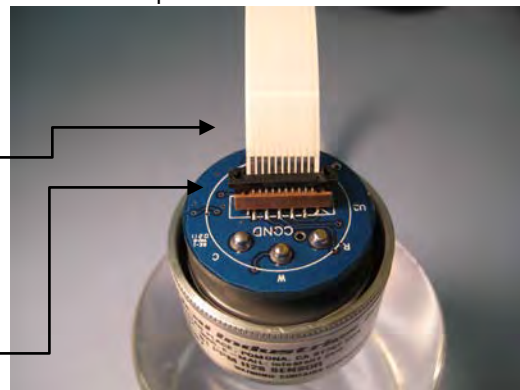

Span Gas Preparation

See Section 4 – Features and Specifications, for exclusions

Note: The GPR-7500AIS-LD must be calibrated by using a certified span gas, preferably 50 to 80% of the range of interest or one range above the range of interest.



Caution: Do not inhale the H₂S span gas. If the analyzer is installed in an enclosed area, when using a span gas, ensure the area is being ventilated by circulating air to flush out H₂S.

Required Components

1. Certified span gas cylinder with an H₂S concentration, balance nitrogen or air, approximating 50-80% of the full scale of the measuring range or one range above the intended measuring range. For example, for analysis on 0-100 PPM range, use a span gas with H₂S concentration ranging from 50-80 PPM
2. A pressure regulator to set the span gas pressure between 5 and 30 psig.
3. Suitable tube fittings and a 4-6 ft. length of metal tubing to connect the pressure regulator outlet to tube fitting designated as SPAN IN on the analyzer panel.

Procedure

1. With the span gas cylinder valve closed, install the pressure regulator on the cylinder.
2. Keep the regulator's exit valve closed and open the cylinder's control knob slowly.
3. Open the cylinder valve completely.
4. Set the pressure between 5-30 psig using the pressure regulator's control knob.
5. Connect the span gas cylinder outlet to the SPAN port of the analyzer
6. Open the pressure regulator exit valve.
7. Set the span gas flow to 1 SCFH

Caution: Do not exceed the recommended flow rate.

Range Selection

The GPR-7500AIS-LD analyzer is equipped with three (3) standard measuring ranges (see specification) and provides users with a choice of sampling modes. By accessing the MAIN MENU, users may select either the AUTO SAMPLING (ranging) or MANUAL SAMPLING (to lock on a single range) mode.

Note: For calibration purposes, use of the AUTO SAMPLE mode is recommended. However, the user can also select the MANUAL SAMPLE mode for calibration but the span gas must not exceed the full scale of the manual range selected – for example, a span gas with 15 PPM H₂S concentration in nitrogen would dictate the use of the 0-20 PPM full scale range for calibration.

Auto Sampling

1. Access the MAIN MENU by pressing the MENU key.
2. Advance the reverse shade cursor using the ARROW keys to highlight AUTO SAMPLE.
3. Press the ENTER key to select the highlighted menu option.

The display returns to the sampling mode:

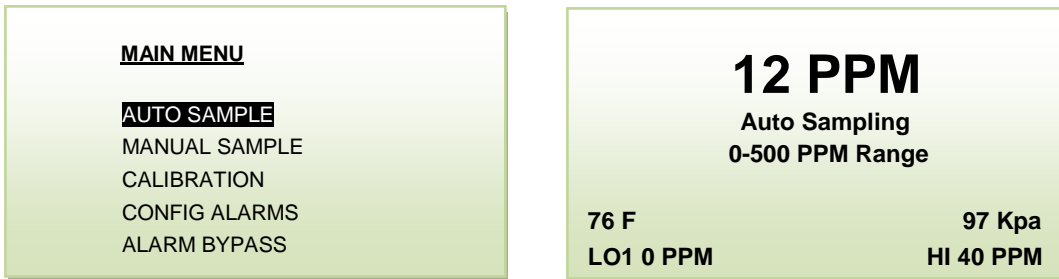

4. The display will shift to the next higher range when the H₂S reading exceeds 99.9% of the upper limit of the current range. The display will shift to the next lower range when the H₂S reading drops to 85% of the next lower range. For example, if the transmitter is reading 20 PPM on the 0-500 PPM range and an upset occurs, the display will shift to the 0-1000 PPM range when the H₂S reading exceeds 500 PPM. Conversely, once the upset condition is corrected, the display will shift back to the 0-500 PPM range when the H₂S reading drops to 400 PPM (85% of 500 PPM).

Manual Sampling

1. Access the MAIN MENU by pressing the MENU key.
2. Advance the reverse shade cursor using the ARROW keys to highlight MANUAL SAMPLE.
3. Press the ENTER key to select the highlighted menu option.

The following display appears:



4. Advance the reverse shade cursor using the ARROW keys to highlight the desired MANUAL RANGE.
5. Press the ENTER key to select the highlighted menu option.

5. Determining the true offset requires the user to wait until the analyzer reading is no longer trending downward (best evidenced by a constant horizontal trend on an external recording device).
6. The zero offset adjustment is limited to 5-20% of the most sensitive range of the analyzer. At factory, analyzer is QC tested to confirm that the maximum offset is less than 5% of the most sensitive range available. Should you observe a zero offset more than 20% of the lowest range, check sample system for any possible leaks, integrity of the zero gas and assure that the analyzer has been given enough time to stabilize on zero gas before initiating the "ZERO CALIBRATION".

Caution: If adequate time is not allowed for the analyzer to establish the true baseline and a ZERO calibration is performed, the analyzer will, in all probability, display a negative reading in the sample mode after a certain period of time. If a negative reading is seen, perform ZERO calibration again

Span Calibration

Involves periodically checking and/or adjusting the electronics to the sensor's signal output at a given H₂S standard. The frequency of calibration varies with the application, e.g., the degree of accuracy required by the application and the quality assurance protocol of the user. However, the interval between span calibrations should not exceed 1 month.

Note: Regardless of the value of the standard used, the span calibration process takes approximately 10-15 minutes

Zero Calibration Procedure

Normally, zero calibration is performed when a new sensor is installed or changes are made in the sample system connections. Before performing a ZERO calibration, it is highly recommended to perform a factory default zero. This will eliminate any previous zero offset adjustment. With factory default setting, a zero offset less than 25% of the lowest range indicates that the integrity of the sensor and electronics is intact. To perform ZERO calibration, from key pad

1. Access the MAIN MENU by pressing the MENU key.
2. Advance the reverse shade cursor using the ARROW keys to highlight CALIBRATION.
3. Press the ENTER key to select the highlighted menu option.

The following displays appear:



4. Advance the reverse shade cursor using the ARROW keys to highlight ZERO CALIBRATE.
5. Press the ENTER key to select the highlighted menu option.

The following displays appear:

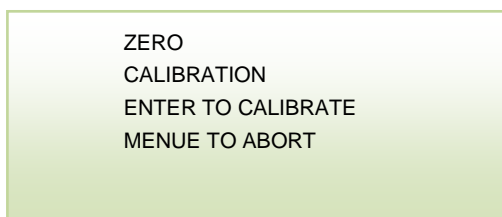

6. Press the ENTER key to calibrate or MENU key to abort and return to SAMPLING mode.
7. Wait for approximately 60 seconds or until the reading has stabilized within 25% of the full scale low range. If the offset is less than 25% of the lowest range, by pressing ENTER, a message PASSED CALIBRATION will appear

and return to the Sample mode. On the other hand, if the offset is above 25% of the lowest range, pressing ENTER, a message FAILED CALIBRATION will appear and the analyzer will return to Sample mode without completing the Zero calibration.

Both the Zero Calibrate and Span Calibrate functions result in the following displays:

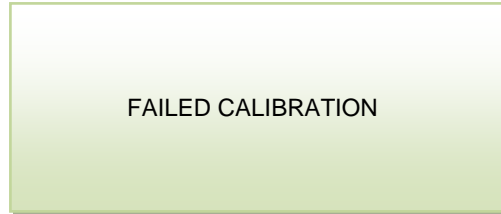
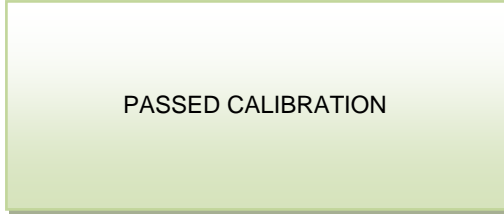

Factory Default Zero Calibration

The feature will eliminate any previous zero calibration and displays the actual signal output of the sensor. For example, assuming a zero gas is introduced, the display above 0.00% will reflect an actual zero offset. This feature allows the user to ensure that the accumulative zero offset never exceeds 25% of the lowest range limit. To perform Default Zero,

1. Access the MAIN MENU by pressing the MENU key.
2. Advance the reverse shade cursor using the ARROW keys to highlight CALIBRATION.
3. Press the ENTER key to select the highlighted menu option.

The following displays appear:

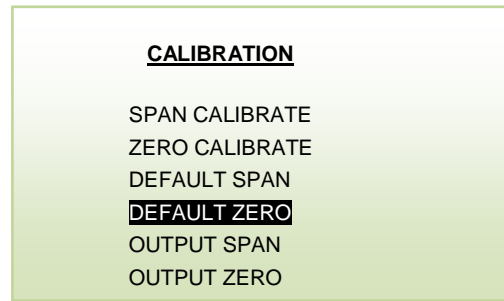
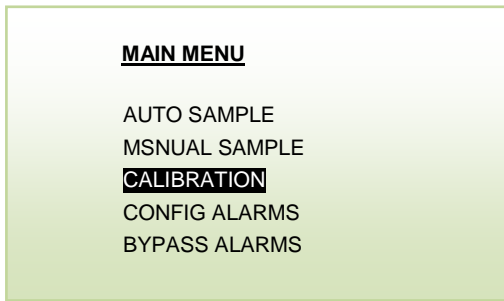

4. Advance the reverse shade cursor using the ARROW keys to highlight DEFAULT ZERO.
5. Press the ENTER key to select the highlighted menu option.

The following display appears and after 3 seconds the system returns to the SAMPLING mode:

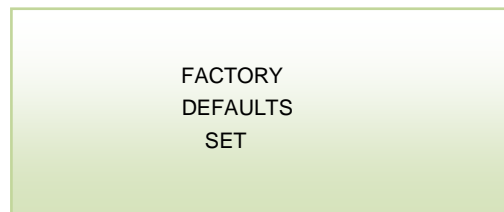

Span Calibration Procedure

This procedure assumes a span gas under positive pressure. Set the span gas and air flow at 1 SCFH (maintaining the sample/span gas to air ratio at 1:1)

For calibration purposes, use AUTO SAMPLE mode.

1. Access the MAIN MENU by pressing the MENU key.
2. Advance the reverse shade cursor using the ARROW keys to highlight AUTO SAMPLE.
3. Press the ENTER key to select the highlighted menu option.

The following displays appear:

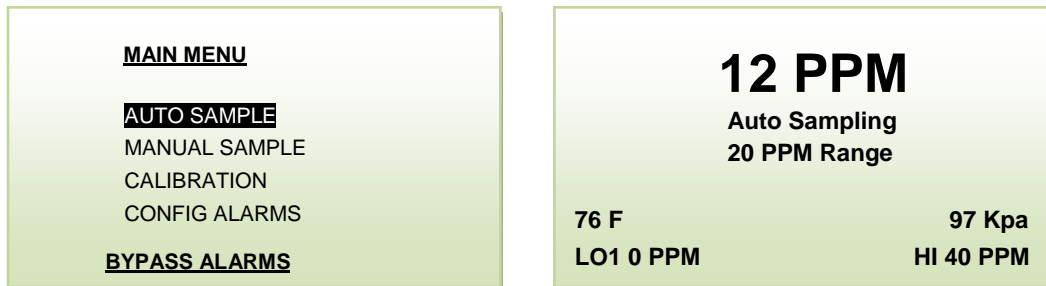

4. Return to the MAIN MENU by pressing the MENU key.
5. Advance the reverse shade cursor using the ARROW keys to highlight CALIBRATION.
6. Press the ENTER key to select the highlighted menu option.
7. Repeat to select SPAN CALIBRATE

The following displays appear:



8. After selecting the SPAN CALIBRATION, the following displays appear:

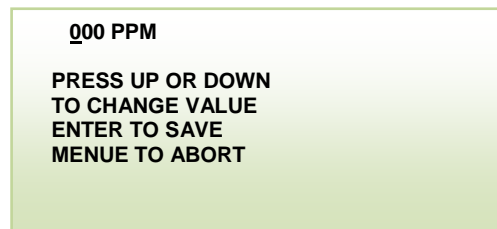

9. Press the ENTER key to advance the underline cursor right or press the MENU key to advance the underline cursor left to reach to the desired digit of the alarm value.
10. Repeat until the complete span value has been entered and press ENTER. The following display will appear showing the real time H2S concentration..

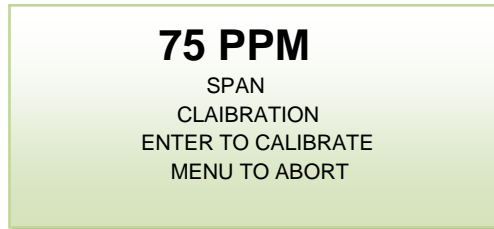

11. Press the ENTER key to accept SPAN CALIBRATION. After successful calibration, the analyzer will display a message "PASSED CALIBRATION" and return to the Sample mode.

NOTE: The analyzer is allowed to accept calibration only when H2S reading is within 50% of the span gas value. If the H2S reading is outside of this limit, by pressing ENTER to accept calibration will result in "FAILED CALIBRATION" and the analyzer will return to the Sample mode without completing Span calibration.

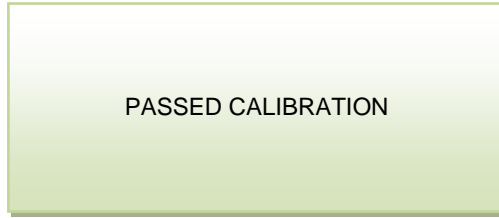
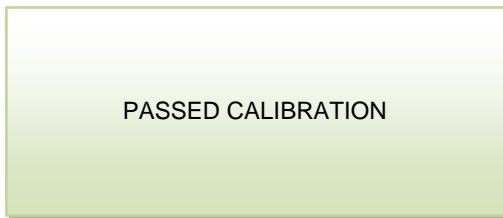

If the calibration is unsuccessful, return to the SAMPLING mode with span gas flowing through the transmitter, make sure the reading stabilizes, reaches within 30-50% (see below) of the span gas value (after factory default span setting) and repeat the calibration before concluding the equipment is defective.

Before disconnecting the span gas line and connecting the sample gas line (if the analyzer is not equipped with a SPAN/SAMPLE vale option), flow the sample gas for 1-2 minutes to purge the air inside the sample line. Disconnect the span gas line and replace it with the sample gas line.

Factory Default Span

With factory default span, previous calibration data stored in the memory is removed and the sensitivity of the analyzer is reset to the value based on the average output of the H2S sensor at a specific H2S concentration. For example, with factory default settings, when a span gas is introduced, the micro-processor will display H2S reading within 30-50% of the span gas value, indicating that the sensor output is within the specified limit.

1. Access the MAIN MENU by pressing the MENU key.
2. Advance the reverse shade cursor using the ARROW keys to highlight CALIBRATION.
3. Press the ENTER key to select the highlighted menu option.

The following display appears:

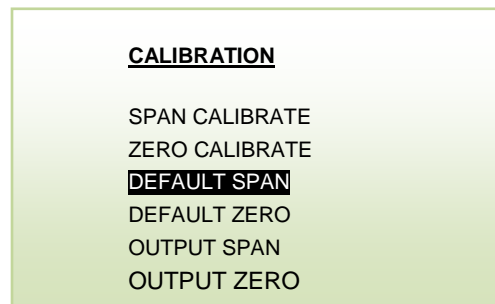
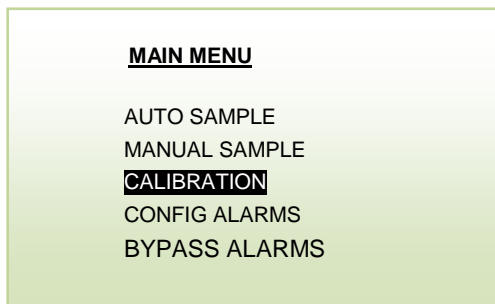

4. Advance the reverse shade cursor using the ARROW keys to highlight DEFAULT SPAN.
 5. Press the ENTER key to select the highlighted menu option.
- The following displays appear and after 3 seconds the system returns to the SAMPLING mode:

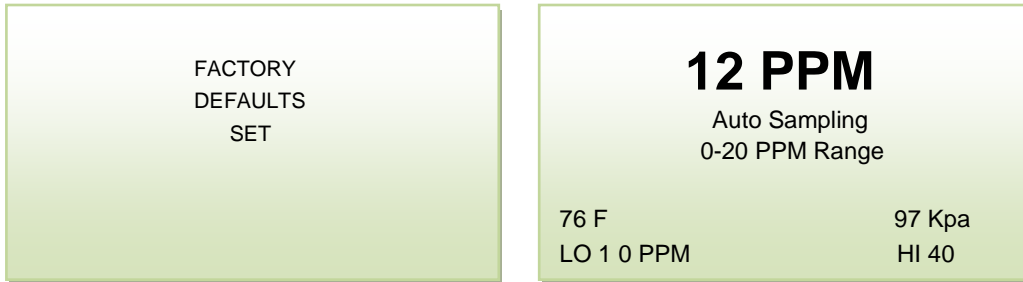

Adjustment of 20 mA Analog Output

In rare instances the 4-20mA signal output may not agree to the reading displayed by the LCD. This feature enables the user to adjust the 20mA signal output should the LCD display not agree.

Note: Adjust the 4mA signal output with the OUTPUT ZERO option described above.

1. Access the MAIN MENU by pressing the MENU key.
2. Advance the reverse shade cursor using the ARROW keys to highlight CALIBRATION.
3. Press the ENTER key to select the highlighted menu option.

The following displays appear:



4. Advance the reverse shade cursor using the ARROW keys to highlight DEFAULT SPAN.
5. Press the ENTER key to select the highlighted menu option.

The following display appears

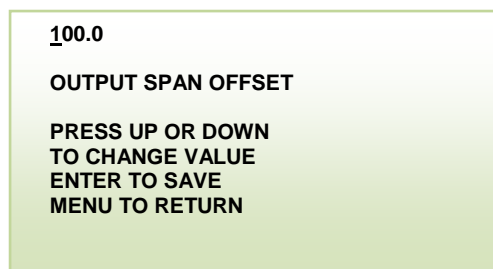

6. The default setting of 100 illustrates no adjustment to the analog output signal. Adjust the initial value to above 100 to increase the 20 mA analog signal value or decrease it below 100 to decrease the 20 mA analog signal.
7. Press the ENTER key to advance the underline cursor right or press the MENU key to advance the underline cursor left to reach to the desired digit of the OUTPUT SPAN OFFSET value.

8. Press the ARROW keys to enter the desired digit. After entering the digit press ENTER and the 20 mA signal will adjust to the new value.
 9. If the 20 mA signal still does not match with 20 mA signal, repeat steps 7 through 8 the 20 mA matches with the display..
 10. Save the adjustment value by pressing the ENTER key or abort by pressing the MENU key.
- The system returns to the SAMPLING mode.

Sampling

After Span and Zero calibration, the analyzer is ready for sampling. GPR-7500AIS-LD H₂S Analyzer requires a positive pressure to flow the sample gas through the flow-through sensor housing to measure the H₂S concentration in a sample gas. The sample gas is continuously blended with air. The ratio of sample to air flow must be maintained at 1:1 at all times.

Procedure

Following calibration, the analyzer automatically returns to the SAMPLE mode.

1. Select the desired sampling mode - auto or manual.
2. Use metal tubing to transport the sample gas to the analyzer.
3. Ensure the sample gas tubing connections fit tightly into the sample input port.
4. Set the air flow rate at 1 SCFH
5. Set the Sample flow rate at 1 SCFH
6. Assure the sample is adequately vented for optimum response and recovery – and safety.
7. Allow the H₂S reading to stabilize for approximately 10 minutes before capturing real time H₂S concentration data..
8. **Note:** To avoid erroneous oxygen readings and damage to the sensor, do not place your finger over the vent (it pressurizes the sensor). Removing your finger (the restriction) generates a vacuum on the sensor and may damage the sensor (voiding sensor warranty)..
9. Avoid the collection of particulates, liquids or condensation on the sensor that could block the diffusion of H₂S into the sensor.

Setting Alarms

The analyzer is equipped with two programmable alarm relays. The two alarms set points are user adjustable and can be set either as LOW/HIGH, LOW/LOW or HIGH/HIGH.

Setting Alarm Delays

Alarm delay option allows the user to ignore the alarm should a sudden short spike in the oxygen reading occurs.

Setting Alarm Bypass

The alarms bypass feature allows the user to bypass the alarm during trouble shooting/repair or test run. However, once the alarm bypass is selected, alarm will remain disabled even if the oxygen reading is over/under the alarm set point. The alarm will re-arm itself only after the fault condition has been reverted.

The alarms are automatically disabled during SPAN/ZERO calibration.

The relays are rated at 1A @ 230V.

CAUTION; When using these relays, do not exceed the recommended rating.

Standby

The analyzer has no special storage requirements.

The sensor should remain inside of the sensor housing and connected to the electronics during storage periods. Before turning the analyzer OFF, ensure that sample system is purged with clean ambient air. This will keep the sample system clean and would be ready to use again when required with very short down time.

Store the analyzer with power OFF at a safe location and away from a direct heating source.

If storing for an extended period of time, protect the analyzer from dust, heat and moisture.

6. Maintenance

Generally, replacing the sensor periodically or replacing filter element of the coalescing filter is the extent of the maintenance requirements of this transmitter.

Serviceability: Except for replacing the sensor, there are no parts inside the transmitter for the operator to service. Only trained personnel with the authorization of their supervisor should conduct maintenance.

7. Spare Parts

Recommended spare parts for the GPR-7500 AIS H2S:

Item No.	Description
GPR-11-72-7H-LM	H2S sensor for measuring up to 2000 PPM H2S
GPR-11-72-7HH-LM	H2S Sensor for measuring up to 100 PPM H2S

Other spare parts:

The Factory must be consulted for any other spare parts and questions related to maintenance

8. Troubleshooting

Symptom	Possible Cause	Recommended Action
Slow recovery	At installation, defective sensor	Replace sensor if recovery unacceptable or H ₂ S reading fails to reach 10% of lowest range
	Air leak in sample system connection(s)	Leak test the entire sample system-correct source of leak
	Damaged in service - electrolyte leakage Sensor nearing end of life	Replace sensor Replace sensor
High H ₂ S reading after installing or replacing sensor	Transmitter calibrated before sensor stabilized Air leak in sample system connection(s)	Allow H ₂ S reading to stabilize before making the span/calibration adjustment Leak test the entire sample system (above)
	Abnormality in zero gas	Qualify zero gas (using portable transmitter)
High H ₂ S reading Sampling	Flow rate exceeds limits Pressurized sensor Improper sensor selection	Correct pressure and flow rate Remove restriction on vent line Install proper sensor
Response time slow	Air leak, dead legs, distance of sample line, low flow rate, high volume of optional filters and scrubbers	Leak test entire sample system, reduce dead volume or increase flow rate
H ₂ S reading doesn't agree to expected values	Pressure and temperature of the sample is different than span gas Error in calibration Abnormality in gas	Calibrate the transmitter (calibrate at pressure and temperature similar to that of sample) Repeat calibration Qualify the integrity of the sample gas (use a portable analyzer as a secondary check)
Erratic H ₂ S reading or	Sudden Changes in sample pressure	Calibrate the transmitter (calibrate at pressure and temperature similar to that of

No H ₂ S reading	Loose sensor cable and or sensor PCB	sample) Maintain sample pressure to within recommended range Secure ribbon cable firmly by fully inserting the ribbon cable into its mating socket on the sensor PCB Ensure that sensor PCB is firmly secured on sensor
	Incorrect polarity of ribbon cable	Ensure that the conductors of ribbon cable align with COND on sensor PCB
	Liquid covering sensing area	Replace sensor
	Sensor nearing end of life	Replace sensor
Cannot span calibrate	Incorrect span gas Span gas pressure too high Span flow rate too high Incorrect sensor Sensor nearing end of life	Check span gas with a secondary analyzer Set span gas pressure within recommended range Set flow rate within recommended range Replace sensor
Cannot zero calibrate	Zero offset outside of recommended range High sample/zero gas flow causing back pressure on sensor	Allow enough time for sensor to settle with zero gas Use ambient air for zero calibration Set sample/zero gas flow within recommended range
	Defective sensor	Replace sensor

9. Warranty

The design and manufacture of GPR Series H2S transmitters/analyzers, monitors and sensors are performed under a certified Quality Assurance System that conforms to established standards and incorporates state of the art materials and components for superior performance and minimal cost of ownership. Prior to shipment every analyzer is thoroughly tested by the manufacturer and documented in the form of a Quality Control Certification that is included in the Owner's Manual accompanying every analyzer. When operated and maintained in accordance with the Owner's Manual, the units will provide many years of reliable service.

Coverage

Under normal operating conditions, the monitor, analyzers and sensor are warranted to be free of defects in materials and workmanship for the period specified in accordance with the most recent published specifications, said period begins with the date of shipment by the manufacturer. The manufacturer information and serial number of this analyzer are located on the rear of the analyzer. Advanced Instruments Inc. reserves the right in its sole discretion to invalidate this warranty if the serial number does not appear on the analyzer.

If your Advanced Instruments Inc. monitor, analyzer and/or oxygen sensor is determined to be defective with respect to material and/or workmanship, we will repair it or, at our option, replace it at no charge to you. If we choose to repair your purchase, we may use new or reconditioned replacement parts. If we choose to replace your Advanced Instruments Inc. analyzer, we may replace it with a new or reconditioned one of the same or upgraded design. This warranty applies to all monitors, analyzers and sensors purchased worldwide. It is the only one we will give and it sets forth all our responsibilities. There are no other express warranties. This warranty is limited to the first customer who submits a claim for a given serial number and/or the above warranty period. Under no circumstances will the warranty extend to more than one customer or beyond the warranty period.

Limitations

Advanced Instruments Inc. will not pay for: loss of time; inconvenience; loss of use of your Advanced Instruments Inc. analyzer or property damage caused by your Advanced Instruments Inc. analyzer or its failure to work; any special, incidental or consequential damages; or any damage resulting from alterations, misuse or abuse; lack of proper maintenance; unauthorized repair or modification of the analyzer; affixing of any attachment not provided with the analyzer or other failure to follow the Owner's Manual. Some states and provinces do not allow limitations on how an implied warranty lasts or the exclusion of incidental or consequential damages, these exclusions may not apply.

Exclusions

This warranty does not cover installation; defects resulting from accidents; damage while in transit to our service location; damage resulting from alterations, misuse or abuse; lack of proper maintenance; unauthorized repair or modification of the analyzer; affixing of any label or attachment not provided with the analyzer; fire, flood, or acts of God; or other failure to follow the Owner's Manual.

Service

Call Advanced Instruments Inc. at 909-392-6900 (or e-mail info@aai1.com) between 7:30 AM and 5:00 PM Pacific Time Monday thru Thursday or 8:00 AM to 12:00 pm on Friday. Trained technicians will assist you in diagnosing the problem and arrange to supply you with the required parts. You may obtain warranty service by returning you analyzer, postage prepaid to:

Advanced Instruments Inc.
2855 Metropolitan Place
Pomona, Ca 91767 USA

Be sure to pack the analyzer securely. Include your name, address, telephone number, and a description of the operating problem. After repairing or, at our option, replacing your Advanced Instruments Inc. analyzer, we will ship it to you at no cost for parts and labor.

10. MSDS – Material Safety Data Sheet

Product Identification

Product Name	H2S sensor Series - OSV
Synonyms	Electrochemical Sensor
Manufacturer	Advanced Instruments Inc., 2855 Metropolitan Place, Pomona, CA 91767 USA
Emergency Phone Number	909-392-6900
Preparation / Revision Date	January 1, 1995
Notes	H2S sensors are sealed, contain protective coverings and in normal conditions do not present a health hazard. Information applies to electrolyte unless otherwise noted.

Specific Generic Ingredients

Carcinogens at levels > 0.1%	None
Others at levels > 1.0%	Acetic Acid or sulfuric acid
CAS Number	Acetic Acid = 64-19-7
Chemical (Synonym) and Family	Potassium Hydroxide (KOH) – Base or Acetic Acid (CH ₃ CO ₂ H) – Acid, Lead (Pb) – Metal

General Requirements

Use	Acid - as electrolyte
Handling	Rubber or latex gloves, safety glasses
Storage	Indefinitely

Physical Properties

Boiling Point Range	Acetic Acid = 100 to 117° C
Melting Point Range	Acetic Acid – NA, Lead 327° C
Freezing Point	Acetic Acid = -40 to -10° C
Molecular Weight	Acetic Acid – NA, Lead = 207
Specific Gravity	Acetic Acid = 1.05 @ 20° C
Vapor Pressure	Acetic Acid = 11.4 @ 20° C
Vapor Density	Acetic Acid = 2.07
pH	Acetic Acid = 2-3
Solubility in H ₂ O	Complete
% Volatiles by Volume	None
Evaporation Rate	Similar to water
Appearance and Odor	Aqueous solutions Colorless, vinegar-like odor, sulfuric acid, no odor

Fire and Explosion Data

Flash and Fire Points	Not applicable
Flammable Limits	Not flammable
Extinguishing Method	Not applicable



Special Fire Fighting Procedures Not applicable

Unusual Fire and Explosion Hazards Not applicable

Reactivity Data

Stability Stable

Conditions Contributing to Instability None

Incompatibility Acid = Avoid contact with strong bases

Hazardous Decomposition Products Acid = Emits toxic fumes when heated

Conditions to Avoid Heat above 70 degree C

Spill or Leak

Steps if material is released Sensor is packaged in a sealed plastic bag, check the sensor inside for electrolyte leakage. If the sensor leaks inside the plastic bag or inside analyzer sensor housing do not remove it without rubber or latex gloves and safety glasses and a source of water. Flush or wipe all surfaces repeatedly with water or wet paper towel (fresh each time).

Disposal In accordance with federal, state and local regulations.

Health Hazard Information

Primary Route(s) of Entry Ingestion, eye and skin contact

Exposure Limits Acetic Acid - ACGIH TLV / OSHA PEL 10 % (TWA)

Ingestion Acetic Acid = Oral LD50 (RAT) = 6620 mg/kg

Eye Electrolyte is corrosive and eye contact could result in permanent loss of vision.

Skin Electrolyte is corrosive and skin contact could result in a chemical burn.

Inhalation Liquid inhalation is unlikely.

Symptoms Eye contact - burning sensation. Skin contact - soapy slick feeling.

Medical Conditions Aggravated None

Carcinogenic Reference Data Acetic Acid = NTP Annual Report on Carcinogens - not listed; LARC Monographs - not listed; OSHA - not listed

Other none.

Special Protection Information

Ventilation Requirements None

Eye Safety glasses

Hand Rubber or latex gloves

Respirator Type Not applicable

Other Special Protection None